

Current Transformers for Measurement

Single Turn Primary Current Transformers for Measurement

The YUANXING TA series Miniature current transformers are designed for applications where AC current signals must be transformed accurately into a lower AC current or voltage signal appropriate for micro-processor based circuits.



The TA2X11 series of PCB Mounted Miniature current transformers are designed specifically for integration into products which require exceptionally accurate primary signal transformation while exposed to harsh environmental operating conditions.

A new TA model can be designed and manufactured to meet the specific design challenges of the client's specific application. The following models are only a small sampling of the many different products which have been and are currently being manufactured.

FEATURES

- Low cost • More than 10 standard sizes
- Non-symmetrical mounting pattern
- Toroidal Silicon steel, Nickel Alloy cores available

SPECIFICATIONS

- Exterior Material: PBT Resin UL flame retardant rating 94-V0
- Interior Insulation: Epoxy Encapsulated
- Isolation Voltage: 2500 Vrms for 1 minute
- Dielectric Resistance: 1000M Ohms @500 Vdc
- Surge Withstand: 5000V (1.2/50 μ s standard shock wave)
- Accuracy Class: as defined in IEC 60044-1 Part 1 Current Transformers Class 0.1, 0.2, 0.5
- Operating Temperature: -25 to +55°C, -40 to +85°C Optional
- Frequency: 50 to 400 Hz • RoHS compliant • CE-approved

APPLICATIONS

- For applications that require exceptional accuracy with minimal phase angle error
- Applications would include Current, Power and Energy monitoring devices

PERFORMANCES

Model	Rated Input	Ratio	Frequency (Hz)	Second burden (Ohms)	Accuracy Class	Outline Dimensions ID-L-W-H (mm)
TA21A11	5~50A	1000: 1 2000: 1	50to400	≤200	0.1, 0.2, 0.5	6.7-23.8-11.6-25.0
TA21B11	5~50A	2500: 1 3000: 1		≤200	0.1, 0.2, 0.5	6.7-23.5-11.5-25.0
TA21C11	5~15A	1000: 1 2000: 1		≤50	0.2, 0.5	4.5-18.0-10.0-20.0
TA21CA11	5~15A	1000: 1 2000: 1		≤300	0.2, 0.5	4.5-19.0-12.5-19.0
TA21E11	5~20A	2500: 1		≤200	0.1, 0.2, 0.5	5.0-21.0-13.5-21.5
TA21F11	5~30A	1000: 1, 2000: 1 2500: 1, 3000: 1		≤200	0.2, 0.5	7.6-23.9-12.0-25.0
TA22B11	5~80A	1000: 1 1500: 1		≤800	0.1, 0.2, 0.5	8.7-26.0-17.5-27.5
TA22D11	5~100A	2000: 1 2500: 1		≤1000	0.1, 0.2, 0.5	9.0-29.5-19.0-30.0
TA22E11	5~100A	3000: 1		≤1000	0.1, 0.2, 0.5	12.8-36.7-14.2-38.5
TA2311	5~20A	1000:1, 2000:1		≤200	0.1, 0.2	5.0-19.0-18.8-20.0
TA23D11	5~20A	1000:1, 2000:1		≤300	0.1, 0.2	5.4-23.0-18.0-23.5
TA23A11	5~100A	1000:1, 2000:1 2500:1, 3000:1		≤1000	0.1, 0.2, 0.5	6.0-34.0-22.0-36.0
TA23B11	5~100A	5000:1		≤100	0.1, 0.2, 0.5	6.0-25.0-21.5-26.0



PART NUMBERS

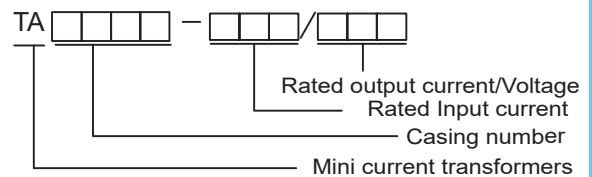

Single turn primary
Measurement

Without DC Immunity
With DC Immunity
Electronic Wattour Meter

Steady Protection

Transient Protection
For Protection Relay

Passive for Fault Recording

Active for Fault Recording

Motor Protection

SHANDONG YUANXING Electronics Co.,Ltd.

Phone: +86-533-381-8450
Fax: +86-533-381-8724

NO.39, QIXIN AVENUE, ZHANGDIAN,
ZIBO, SHANDONG, CHINA 255095

www.yuanxing.net
sales@yuanxing.net

Typical Impedance Dependence of Phase and Amplitude Errors(test temperature 25° C)

TA21B11-5(20)A/2.5mA Nickel Alloy cores

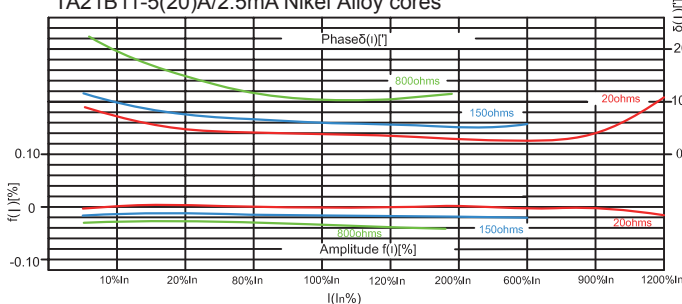

TA21B11-5(20)A/2.5mA Nacocrystalline core

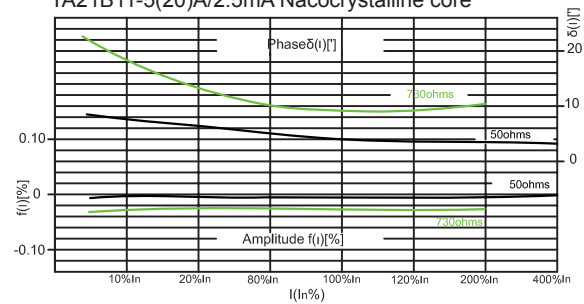

TA21B11-5(20)A/2.5mA Silicon Steel core

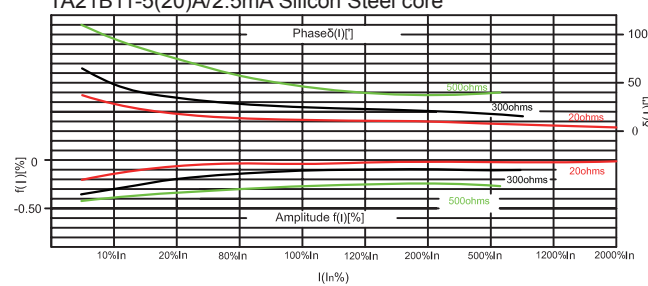

TA21C11-5A/2.5mA Nickel Alloy cores

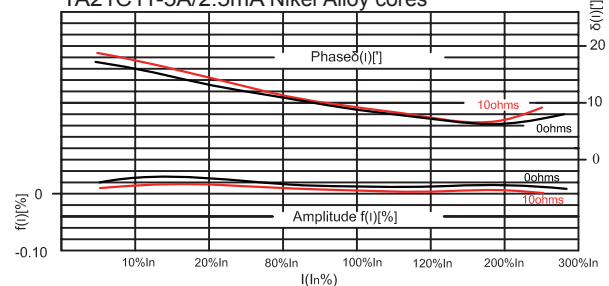

TA21C11-5A/2.5mA Silicon Steel core

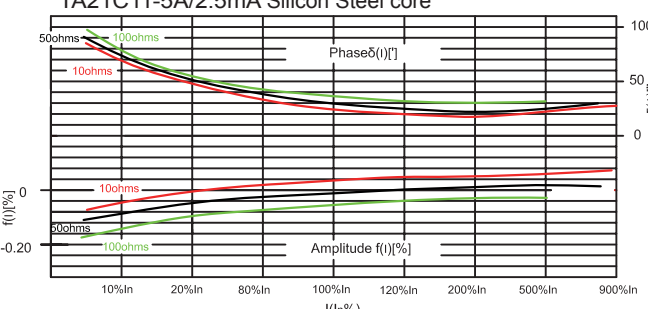

TA22D11-20(100)A/10mA Nacocrystalline core

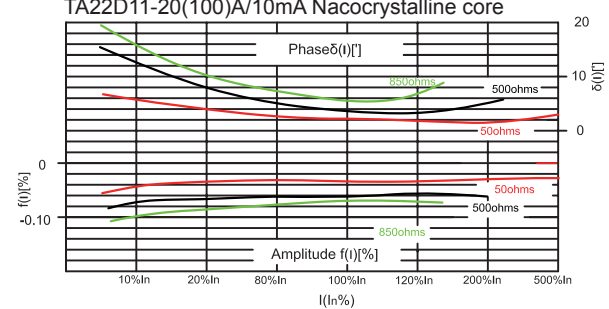

TA22D11-20(100)A/10mA Silicon Steel core

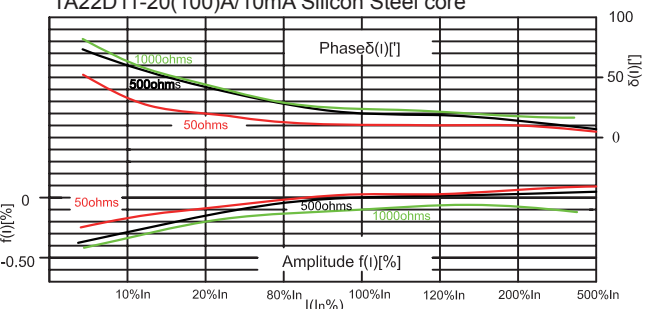

TA2311-5(50)A/2.5mA Silicon Steel core

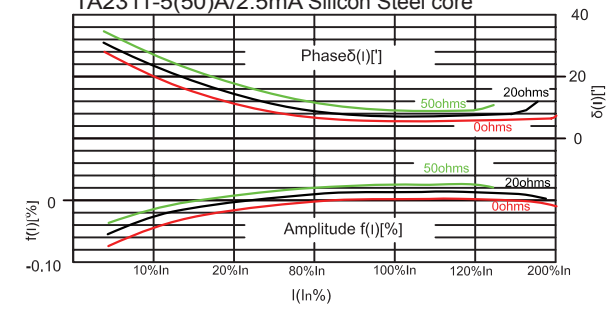

TA2311-5(50)A/2.5mA Nickel Alloy cores

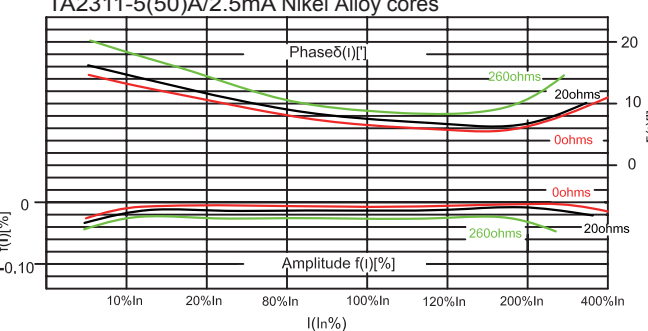

Measurement
Single turn primary
Wound primary

Electronic Wattour Meter
Without DC Immunity
With DC Immunity

For Protection Relay
Steady Protection
Transient Protection
Passive for Fault Recording
Active for Fault Recording

Motor Protection

OUTLINE DRAWINGS

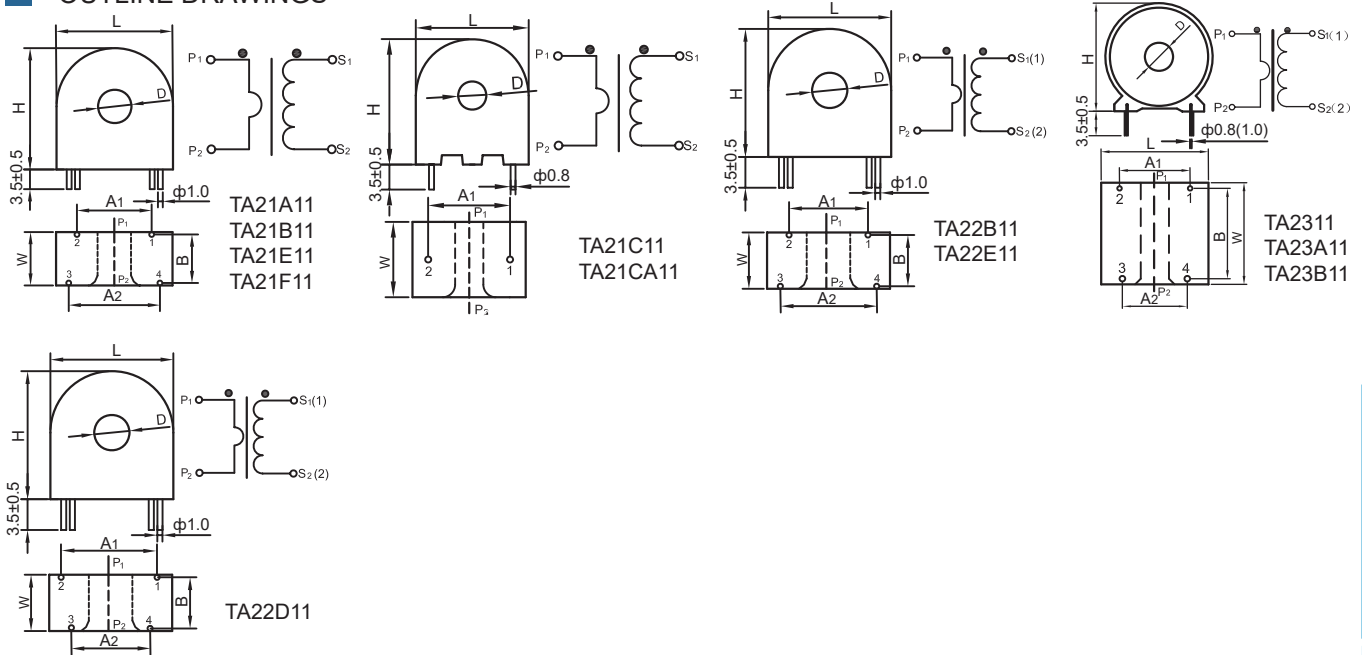

OUTLINE DIMENSIONS

Unit:mm (inch)

Model	L	W	H	A1	A2	B	D
TA21A11	23.8(0.937)	11.6(0.457)	25.0(0.984)	20.32(0.800)	15.24(0.600)	9.4(0.370)	6.7(0.264)
TA21B11	23.5(0.925)	11.5(0.453)	25.0(0.984)	15.24(0.60)	19.05(0.75)	10.16(0.40)	6.7(0.264)
TA21C11	18.0(0.709)	10.0(0.394)	20.0(0.787)	13.0(0.512)	—	—	4.5(0.177)
TA21CA11	19.0(0.748)	12.5(0.492)	19.0(0.748)	13.0(0.512)	—	—	4.5(0.177)
TA21E11	21.0(0.827)	13.5(0.513)	21.5(0.846)	16.51(0.65)	12.7(0.50)	12.2(0.480)	5.0(0.197)
TA21F11	23.9(0.941)	12.0(0.472)	25.0(0.984)	15.2(0.598)	15.2(0.598)	6.5(0.256)	6.7(0.264)
TA22B11	26.0(1.024)	17.5(0.689)	27.5(1.083)	15.24(0.60)	17.78(0.70)	16.0(0.63)	8.7(0.343)
TA22D11	29.5(1.161)	19.0(0.748)	30.0(1.181)	22.0(0.866)	19.0(0.748)	17.5(0.689)	9.0(0.354)
TA22E11	36.7(1.445)	14.2(0.559)	38.5(1.516)	25.2(0.992)	32.8(1.291)	11.5(0.453)	12.8(0.504)
TA2311	18.8(0.740)	17.8(0.701)	19.5(0.768)	13.0(0.512)	11.2(0.441)	16.5(0.650)	5.0(0.197)
TA23A11	34.0(1.339)	22.0(0.886)	36.0(1.417)	20.32(0.80)	10.16(0.396)	20.0(0.787)	6.0(0.236)
TA23B11	25.0(0.984)	21.5(0.846)	26.0(1.024)	20.32(0.800)	10.16(0.396)	20.0(0.787)	6.0(0.236)
TA23D11	23.0(0.906)	18.0(0.709)	23.5(0.925)	13.0(0.512)	11.2(0.441)	16.5(0.650)	5.4(0.213)

MINIATURE CT,s

Single turn primary Measurement

Wound primary

Without DC Immunity

With DC Immunity

Steady Protection

Transient Protection

Passive for Fault Recording

Active for Fault Recording

Motor Protection

SHANDONG YUANXING Electronics Co.,Ltd.

Phone: +86-533-381-8450
Fax: +86-533-381-8724

NO.39, QIXIN AVENUE, ZHANGDIAN,
ZIBO, SHANDONG, CHINA 255095

www.yuanxing.net
sales@yuanxing.net

APPLICATION EXAMPLE

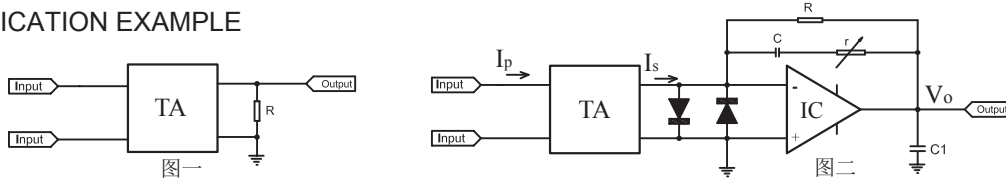

Application circuit is as figure I, the secondary directly connect the sampling resistor in parallel to get the required voltage value. Advantage: Sampling circuit is simple. Disadvantage: When the secondary burden resistance is too bigger, the ratio error and phase error of CT will increase, the linearity will decrease, and the linearity range will be narrowed down, and will even cause saturation and output waveform distortion. Recommend customer to apply the circuit as figure II, the CT secondary output connects the operational amplifier I/V converting circuit to improve the load capacity of CT, and the CT works on zero load state. To get the required voltage value by adjusting the value of feedback resistor R. The capacitance C and adjustable resistor r are used to compensate phase shift, to get the required compensation accuracy by adjusting the compensation resistor r value. When there is no need to compensate phase shift, the capacitance C and adjustable resistor r can be unconnected. The IC in figure II can use OP07. The confirmation of feedback circuit parameters is as below.

① The value of feedback resistor R: Feedback resistor $R = V_o / I_s$. If the output voltage needs to be very accurate, we can choose R which value is slightly smaller than V_o / I_s and connect a adjustable resistor in series to adjust finely to get the required accuracy.

② The value of capacitance C and adjustable resistor r: The empirical value of C is usually 0.01~0.033 μ F.

If the C is 0.033 μ F, then $r = 95x\sqrt{22R / \Phi_c - 1}$

If the C is 0.022 μ F, then $r = 143x\sqrt{15R / \Phi_c - 1}$

And the unit of feedback resistor R is K Ω ; Φ_c is the phase error of rated point when the CT is in zero load state, the unit is minute; the unit of counted compensation resistor r is K Ω .

Application Sample:

Use TA23B11-5A/2.5mA to design a circuit, which rated input current is 5A, rated output voltage is 5V, (the Φ_c marked on TA23B11-5A/2.5mA is 15'), the circuit is as figure II, the parameters are confirmed as below: Feedback resistor $R = V_o / I_s = 5V / 2.5mA = 2K\Omega$.

Capacitance C and compensation resistor r: If the C is 0.033 μ F, then $r = 95x\sqrt{22R / \Phi_c - 1} = 95x\sqrt{22x2 / 15 - 1} = 132K\Omega$

If the C is 0.022 μ F, then $r = 143x\sqrt{15R / \Phi_c - 1} = 143x\sqrt{15x2 / 15 - 1} = 143K\Omega$